

2005- Chevrolet Cobalt SS / Saturn Ion Redline - I4 2.0 SC / 2.4 L

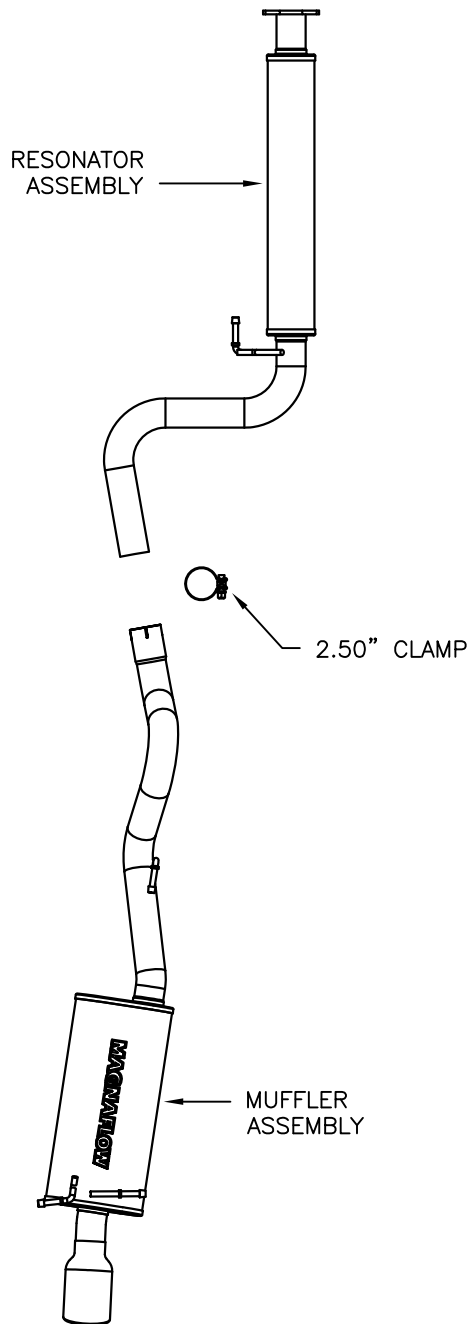

Warning: When working on, under, or around any vehicle exercise caution. Please allow the vehicle's exhaust system to cool before removal, as exhaust system temperatures may cause severe burns. If working without a lift, always consult vehicle manual for correct lifting specifications. Always wear safety glasses and ensure a safe work area. Serious injury or death could occur if safety measures are not followed.

Step 1: (Carefully read all instructions before installation) Disconnect the vehicle's battery before removal of the OEM exhaust. This will allow the computer to reset itself with the new system, and prevent electrical accidents. You will need to cut the OEM exhaust behind the resonator, where the pipe bends up over the rear axle. You can now unbolt the flange in front of the resonator, disengage the welded hangers from the rubber insulators, and remove the system from the vehicle. Do not discard or damage the OEM fasteners, gasket, and rubber insulators, as they may be reused to mount the new system.

Step 2: Install the new resonator assembly by fitting the welded hanger into the OEM rubber insulator, and by bolting the flange to the catalytic converter using the supplied fasteners. Leave all clamps and fasteners loose for final adjustment of the complete system. Next install the muffler assembly in a similar fashion using the supplied 2.50" clamp. Use the supplied rubber insulators at the rear of the muffler in place of the OEM pieces for 2.4 liter models, or as needed for extra clearance.

Step 3: With all components mounted loosely, adjust the system for overall aesthetics and clearance of frame & bodywork. (MAGNAFLOW recommends at least 1/2" of clearance between the exhaust system and any body panels to prevent heat-related body damage or fire.)

Step 4: Once a final position has been chosen for the new system, evenly tighten all fasteners from front to rear. The supplied band clamps must be VERY tight to properly align the pipes and prevent leaks (approximately 40ft-lbs.). U-bolt clamps should be tightened to approximately 30-35ft-lbs. Inspect all fasteners after 25-50 miles of operation and retighten if necessary.

*MAGNAFLOW Performance Exhaust recommends professional installation on all their products

Technical support: 1-800-959-9226 ext. 4500

MAGNAFLOW Performance Exhaust - 22961 Arroyo Vista - Rancho Santa Margarita, CA 92688