



# INSTALLATION INSTRUCTIONS

## F-BOMB | DYNA®

### MINIMUM REQUIRED TOOLS:



FLAT HEAD SCREWDRIVER



1/2", 9/16", 14mm, 7/8" or 22mm WRENCHES



5/16", 1/2", 9/16" SOCKETS AND RATCHET



SNAP RING PLIERS



3/16", 1/4", 5/16" ALLEN WRENCH



TORQUE WRENCH

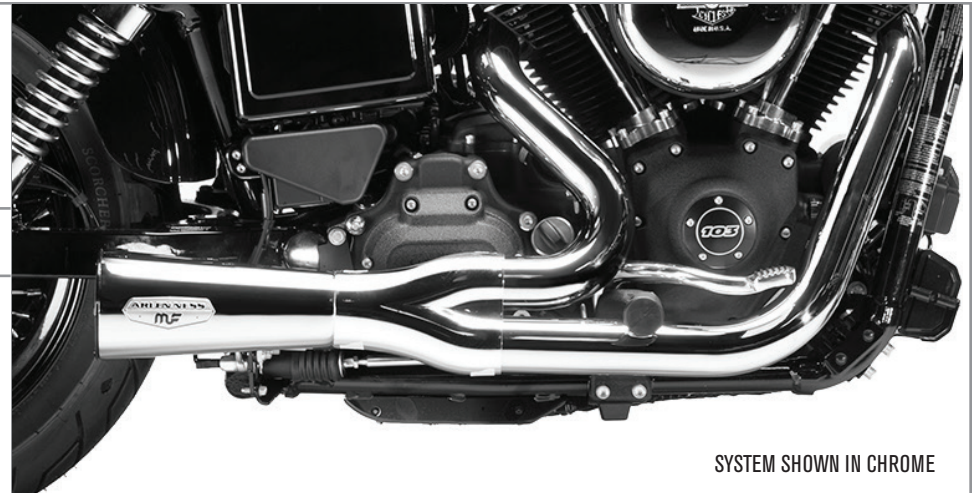

SYSTEM SHOWN IN CHROME

### INCLUDED HARDWARE:

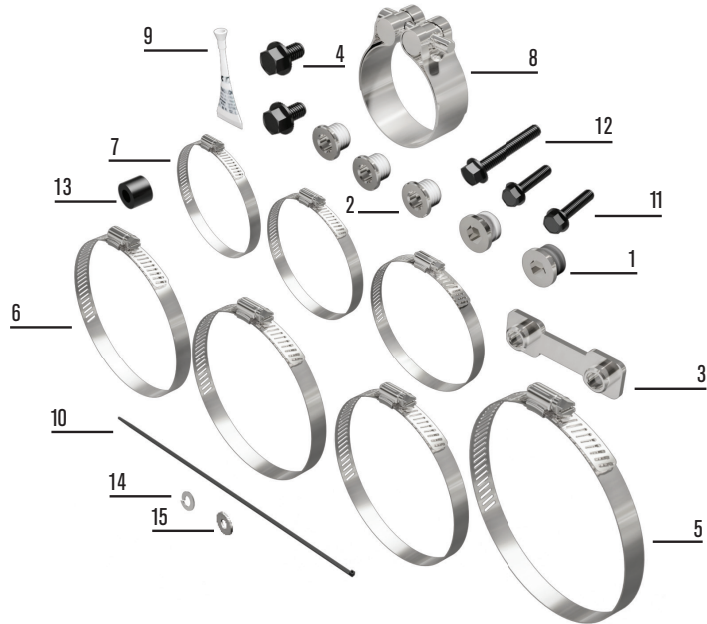

- |                                |                              |                                      |
|--------------------------------|------------------------------|--------------------------------------|
| 1. (2) O2 ADAPTER              | 6. (3) HS CLAMP 2.00inch     | 11. (2) BOLT HEX 5/16-18 x 1 1/2     |
| 2. (3) O2 PLUG SOCKET          | 7. (3) HS CLAMP 1.75inch     | 12. (1) BOLT HEX 5/16-18x2           |
| 3. (1) NUT PLATE 3/8-16        | 8. (1)MUFFLER CLAMP 2.25inch | 13. (1) SPACER                       |
| 4. (2) BOLT HEX 3/8-16 x 0.625 | 9. (1)THREADLOCK             | 14. (1) WASHER SPLIT LOCK 5/16" ZINC |
| 5. (1) Y-HS SS 36mm            | 10. (1) CABLE TIE            | 15. (1) WASHER FLAT 5/16" SAE ZINC   |

**CHROME** PART # 7212601  
**BLACK** PART # 7213102

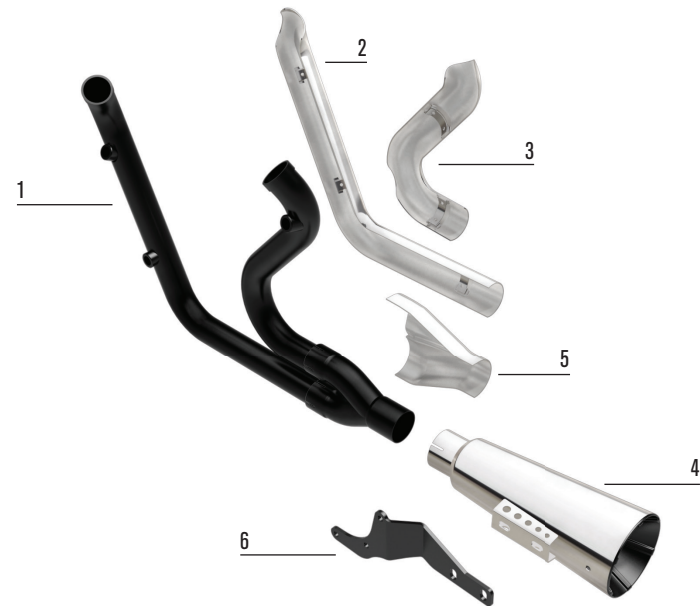

- |                      |                     |                     |
|----------------------|---------------------|---------------------|
| 1. FRONT HEAD PIPE   | 3. REAR HEAD SHIELD | 5. Y-HS COLLECTOR   |
| 2. FRONT HEAD SHIELD | 4. MUFFLER          | 6. MOUNTING BRACKET |



# IMPORTANT INFORMATION

1. Register your new product at [www.magnaflow.com/motorcycle/register](http://www.magnaflow.com/motorcycle/register).
2. When installing new MagnaFlow exhaust systems, be sure your hands are clean and free of oil, lotion or similar products. After installation is completed and before starting the motorcycle, thoroughly clear the new exhaust system with a clean, soft cloth and cleaning solvent that leaves no residue. Debris, residue or fingerprints left on the system may cause damage to the finish. Damage or discoloration to finish is not covered by warranty.
3. MagnaFlow advises replacing worn or damaged gaskets.
4. Make sure there are no exhaust leaks at the junctions and connecting points of the exhaust pipes and/or mufflers, or at the cylinder.
5. Leaks due to improper installation may cause the engine to overheat. This may cause discoloration.

Maximize your motorcycles performance and efficiency by complementing your new MagnaFlow exhaust system with a fuel tuner management system and or EFI remapping. Remapping is suggested to optimize performance while reducing the possibility of damage to your motor or new exhaust system.

NOTICE: MagnaFlow makes every effort to design exhaust systems which enhance the riding experience. However, due to restraints on some models, tolerances, ground and or cornering clearance may not improve and in some cases may be reduced. Adjustments to the motorcycle not listed here may be required for proper fitment. Be sure to carefully follow all installation instructions.

**DISCLAIMER: NOT LEGAL FOR SALE OR USE IN CALIFORNIA ON ANY POLLUTION CONTROLLED MOTOR VEHICLES.**

Some part numbers not available in California. The California Air Resources Board (CARB) does not permit the use of aftermarket emission-related part(s) that alter the performance of OEM emission-related devices unless CARB has issued an Executive Order. Check Federal, State and local laws for compliance.

Platforms, model names and descriptions including but not limited to Dyna®, Softail®, Sportster®, Touring®, Fat Boy®, Road Glide®, Heritage® and Harley® are registered trademarks of The Harley-Davidson Motor Company®, Milwaukee, WI, U.S.A.

## CALIFORNIA EMISSIONS NOTICE

Some part numbers are not legal for sale or use in California. The California Air Resources Board (CARB) does not permit the use of aftermarket emission-related part(s) that alter the performance of OEM emission-related devices unless CARB has issued an Executive Order, other than on racing vehicles on closed courses. Check your local laws and manufacturer's information.

In California, the sale and installation of motorcycle aftermarket exhaust parts that may have the potential to impact emissions are regulated by the California Air Resources Board (CARB). The sale, installation and use of emissions related aftermarket exhaust parts on motorcycles is prohibited unless the exhaust part is either an OEM "replacement part" as defined by the state of California, or is specifically permitted for use by an Executive Order issued by CARB.

### (1) Replacement Parts

Replacement Parts are aftermarket parts that are functionally identical to the stock OEM part they are intended to replace, and therefore do not adversely impact emissions when installed and in use. Replacement Parts are permitted for sale, installation and use on motorcycles used on or off the public highways in California. For motorcycles, these parts fall in to two categories:

## CALIFORNIA EMISSIONS NOTICE (CONT.)

\* No emission control - If the motorcycle's stock exhaust system does not contain any emission control components, then an aftermarket exhaust part is a Replacement Part and no EO is required.

\* Upstream emission control devise. If the motorcycle's stock exhaust system contains a catalytic converter, then an aftermarket exhaust part positioned downstream from the catalytic converter (i.e. cat-back) is a Replacement Part as long as it does not remove, replace or adversely affect any emission control equipment originally attached to the stock exhaust system.

### (2) Executive Order Parts

All exhaust parts that incorporate or impact any emission control devise require a CARB issued Executive Order allowing the parts to be advertised, sold, offered for sale and installed in California, pursuant to specific application.

For more information please visit <http://www.arb.ca.gov/msprog/aftermkt/motorcycle1/motorcycle1.htm>

## WARRANTY:

MagnaFlow motorcycle exhaust products, including Arlen Ness by MagnaFlow exhaust systems, are warranted against defects in material and/or assembly workmanship only for a period of 1 year from invoice date. This warranty is void if the product is not installed properly on the vehicle for which it is designed. This warranty does not apply to any product which has been installed on any commercial or racing vehicle or which has been improperly installed, modified, altered or subjected to misuse or damage from accidents; including excessive heat. Also, cost of labor and any additional parts or components required to complete installation of a replacement product are not covered by this warranty; including coatings, paints and/or finishes, flaws or rust. MagnaFlow including Arlen Ness by MagnaFlow exhaust systems are designed to fit and operate on original OEM motors and chassis with no modifications of any type on the motorcycle.

Proof of purchase from an authorized retailer must accompany any warranty claim. The original product that is deemed to be under warranty may only be returned and/or exchanged for a product of the same part number. No other warranty, expressed or implied (including merchantability), applies to the products, nor is any person including the manufacturer authorized to assume any other warranty. Dealers and distributors are not authorized to make warranty judgments or claims regarding MagnaFlow products. The manufacturer does not assume any responsibility for any consequential damages occasioned by the product, or inconvenience or interruption in any operation, service or shipping. All approved warranty returns must be accompanied by a return authorization number. Parts returned to MagnaFlow without a return authorization and accompanying documentation may be refused. No parts will be accepted with freight due.

This warranty gives you specific legal rights. You may also have other rights which may vary from state to state. Some states do not allow the exclusion or limitation of incidental or consequential damages, so the above limitation or exclusion may not apply to you.

The warranties set forth herein are exclusive and, unless otherwise required by applicable law, no other warranties are made by MagnaFlow or are authorized to be made with respect to the product.



## STOCK EXHAUST REMOVAL INSTRUCTIONS

### PLEASE NOTE:

Several MagnaFlow motorcycle exhaust systems are designed to be used with O2 and non-O2 sensor applications. If your motorcycle does not come equipped with O2 sensors, simply skip any steps referring to them.

1. Locate both the front and rear O2 sensors and unplug them from the factory wiring harness. Remove any cable ties holding them in place. Note the wiring location and routing.
2. Carefully remove the two mounting nuts located at each flange holding the head pipes to the cylinders. It may be necessary to loosen or remove the heat shields for better access. Make sure to retain the nuts as they will be used during the installation.
3. Locate the exhaust bracket mounted to the frame and remove the clamping bolt.
4. On each muffler, remove the bolts attaching them to the exhaust mounting bar and remove the stock exhaust pipes, and mufflers. Make sure to prevent any damage to the O2 sensors since they will be reused.
5. Remove the O2 sensor using a 7/8 inch or 22 mm wrench. To insure continued performance from your stock O2 sensors, keep any fingerprints, debris or chemicals from the tip.
6. Remove the foot controls along with the brake rod by removing the T30 screw or e-clip from the rear eyelet.
7. Remove the remaining bolts and washers holding the exhaust mounting bar. Note and save this hardware as they will be used during the installation.
8. From the stock exhaust system, remove the circlips and mounting flanges to reuse with the new system. Be sure to replace any reused hardware that is worn or damaged before installing your MagnaFlow motorcycle exhaust system.



## INSTALLATION INSTRUCTIONS

### PLEASE NOTE:

Several MagnaFlow motorcycle exhaust systems are designed to be used with O2 and non-O2 sensor applications. If your motorcycle does not come equipped with O2 sensors, simply skip any steps referring to them. It will be necessary to install the supplied O2 sensor plugs during the installation process.

1. Install the supplied, MagnaFlow exhaust mounting bracket using the two 5/16-18 x 1 1/2 inch bolts, 5/16-18 x 2 inch bolt, and spacer (Figure 1a, 1b).

Fig 1a

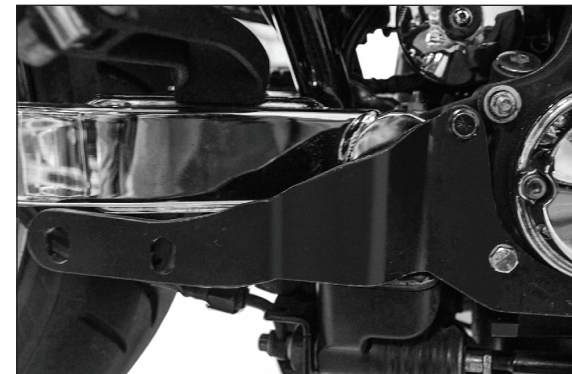
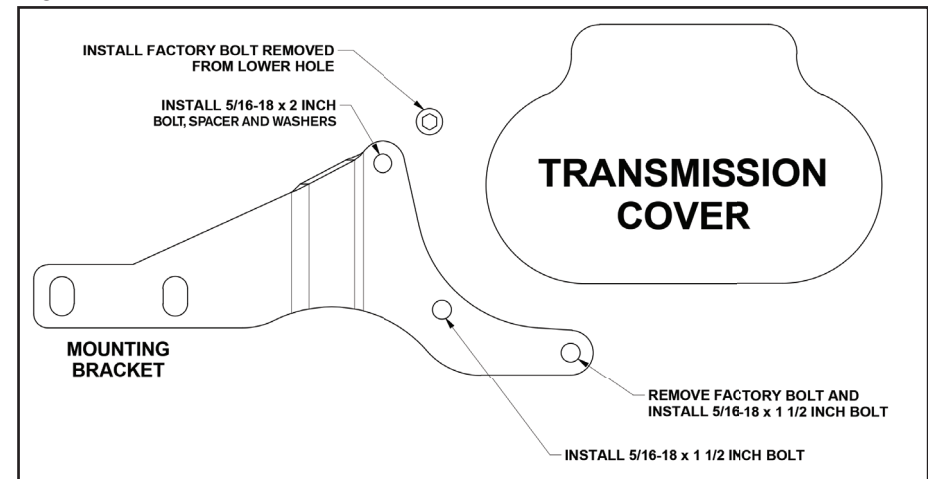

Fig 1b

2. Re-install the foot controls and brake rod.
3. Install the factory mounting flanges and circlips, removed from the factory system, on the new head pipes. (Figure 2)



Fig 2

4. Carefully install the factory O2 sensors into the new head pipes.
5. Install the head pipe assembly to the exhaust port using the factory exhaust port nuts. Do not tighten the nuts at this time to allow for adjustment. (Figure 3)

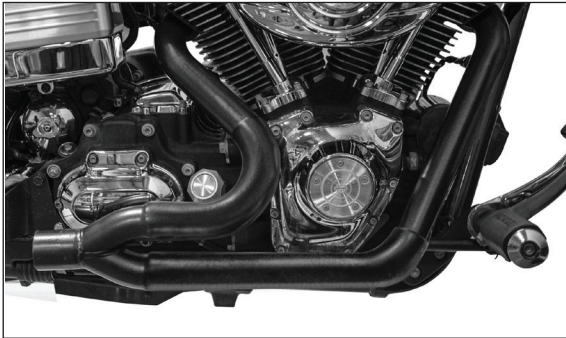

Fig 3

6. Re-route and plug in the O2 sensors to the factory harness. Secure the harness wire using the supplied cable tie.
7. Insert the supplied heat shield clamps to the heat shields by inserting the end of the clamp through the retaining bracket. (Figure 4)



Fig 4

8. Attach the front and rear heat shields to the head pipe assembly using the heat shield clamps. Do not tighten the clamp at this time to allow for adjustment. (Figure 5)

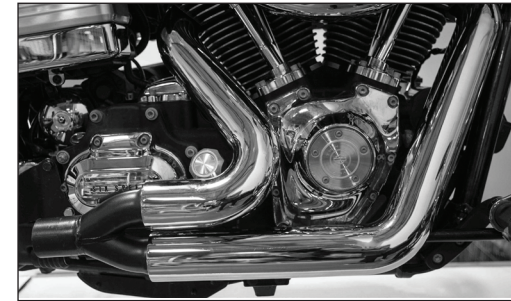

Fig 5

9. Install the Y-collector heat shield by sliding the front retaining clips inside the head pipe heat shields, then attaching the 2.25 inch heat shield clamp to the Y-collector (Figure 6). Do not tighten the bolts at this time to allow for adjustment.



Fig 6

10. Install the muffler to the head pipe assembly using the 2.25 inch muffler clamp. Attach the muffler to the mounting bracket using the two 3/8-16 x 5/8 inch bolts and 3/8-16 nut plate (Figure 7a, 7b). Do not tighten the nuts at this time to allow for adjustment.



Fig 7a



Fig 7b

11. Adjust the exhaust system as necessary and tighten all of the bolts and clamps.
12. Before starting the motorcycle, make sure to check that all of the exhaust components including O2 wiring have been properly installed and have proper clearance to avoid damage. Make sure that all hardware has been tightened to factory specifications. Please reference item 2 on the Important Information page.
13. Make sure to start the motorcycle first time in a well-ventilated area as the system may smoke from residue bending lubricate and heat cycling of the head pipe coating.

Note: Remapping the EFI unit is suggested to optimize performance while reducing the possibility of damage to your engine or new exhaust system.